





-  Drzwi wejściowe, otwierane do wewnątrz
-  Porte d'entrée, ouverture vers l'intérieur
-  Deur, naar binnen opendraaiend
-  Eingangstür, nach Innen öffnend
-  Porta d'ingresso, l'apertura verso interno





# BluEvolution 92 **bE**

170 820 - 371 040

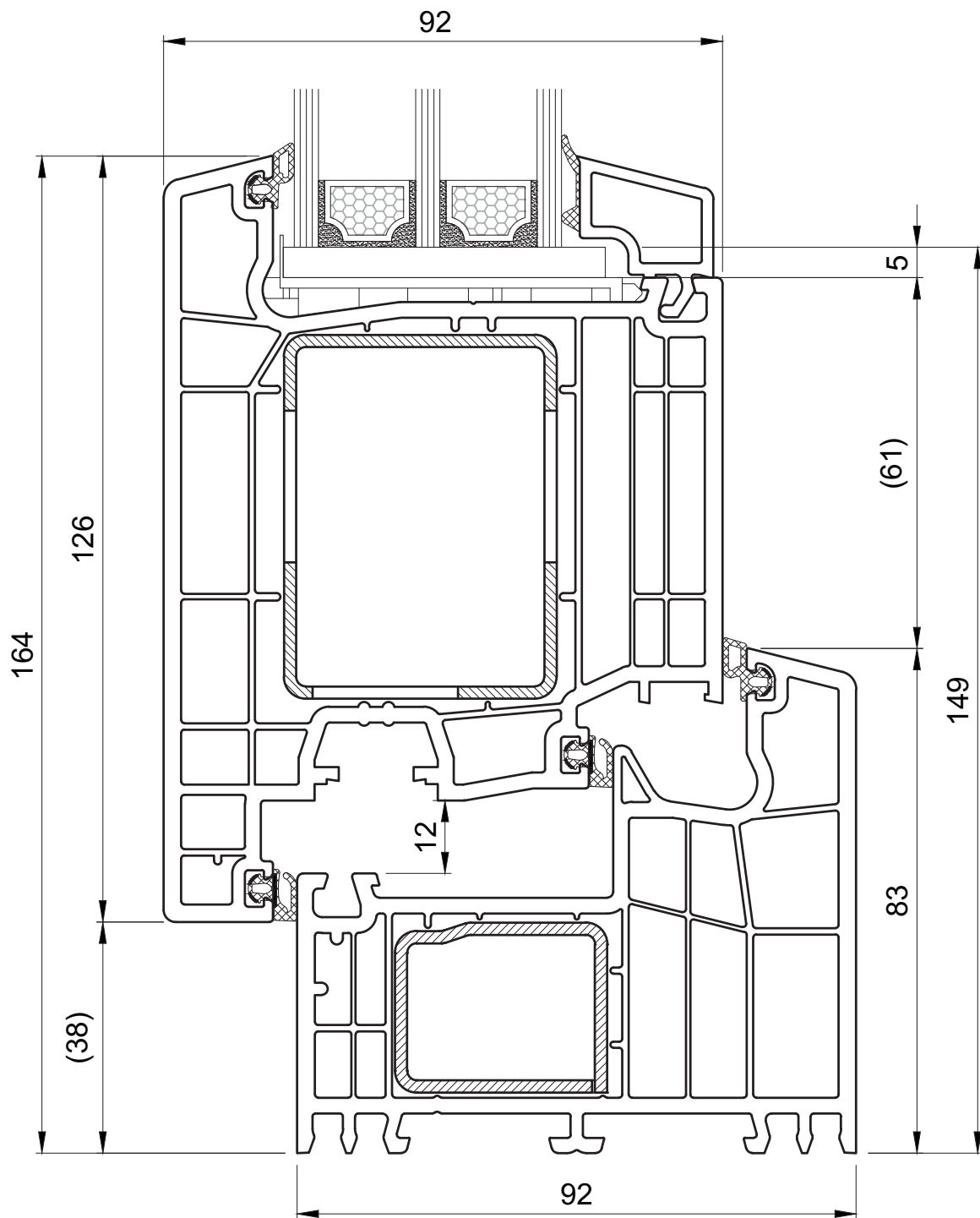

Drzwi wejściowe, otwierane na zewnątrz



Porte d'entrée, ouverture vers l'extérieur



Deur, naar buiten opendraaiend



Eingangstür, nach Aussen öffnend



Porta d'ingresso, l'apertura verso esterno



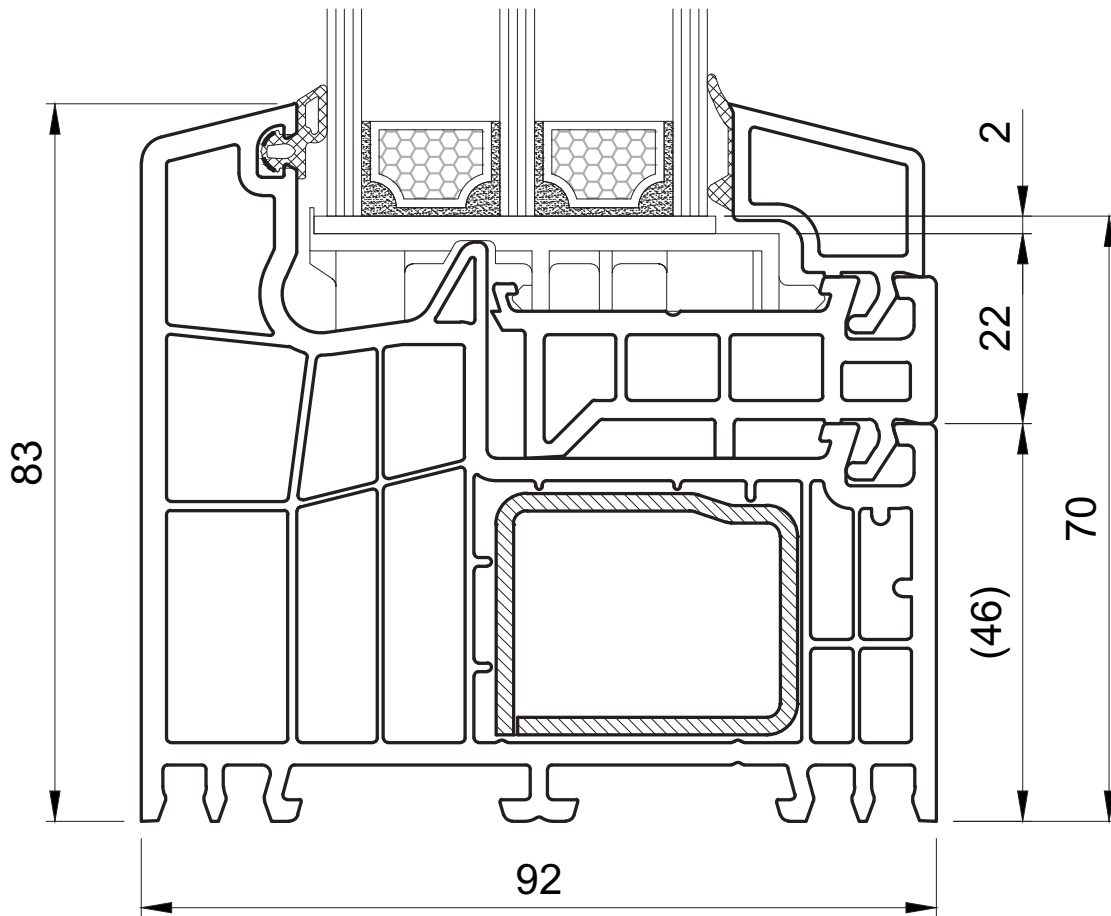

-  Szklenie w ramie
-  Dormant standard
-  Kader standard
-  Standardrahmen
-  Telaio standard





# BluEvolution 92 **bE**

170 430 - 171 020

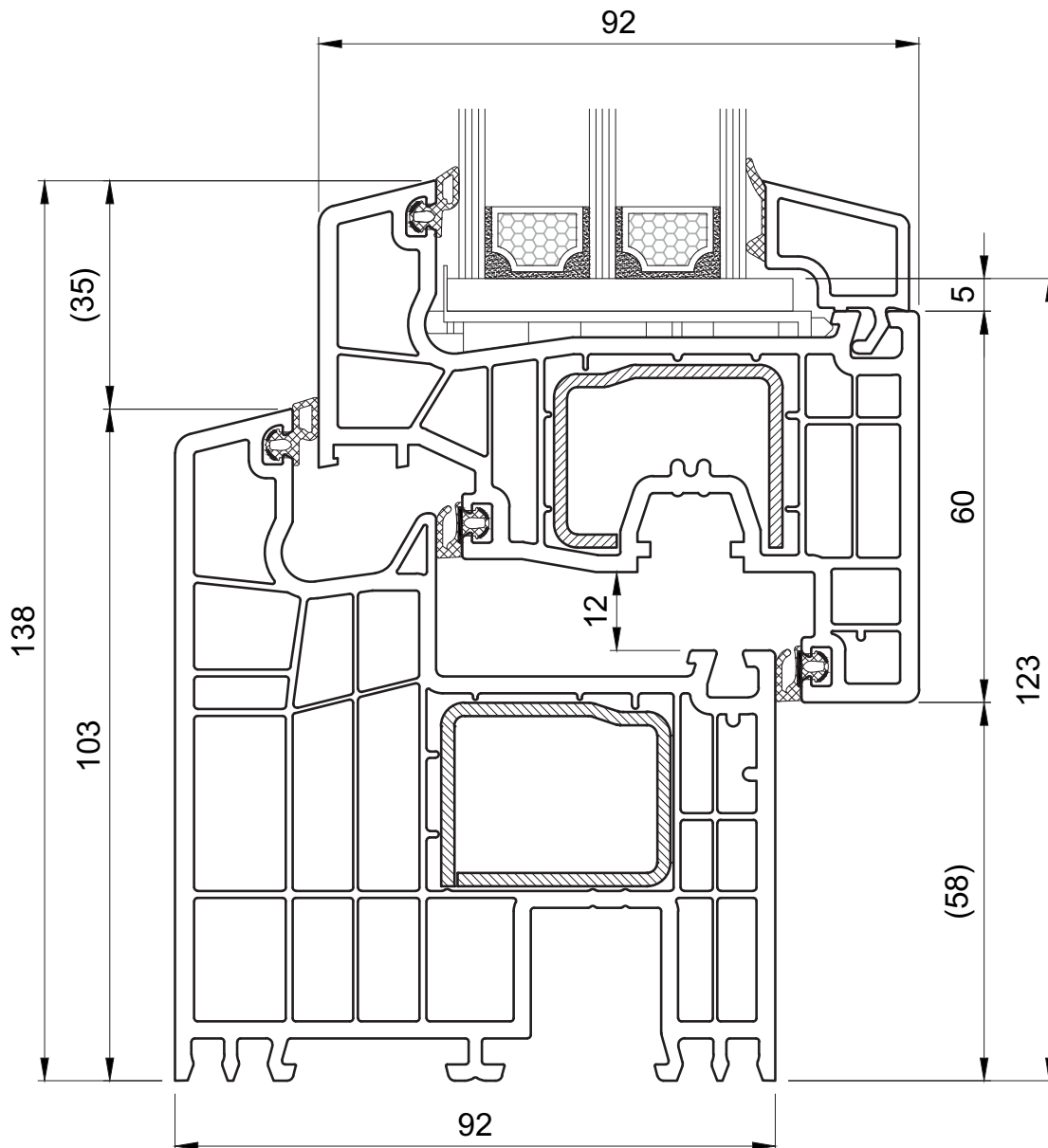

Skrzydło okienne Classic-line z ramą 103 mm



Ouvrant Classic-line avec dormant 103 mm



Vleugel Classic-line + kader 103 mm



Flügel Classic-line mit Rahmen 103 mm







Ante Classic-line con telaio 103 mm

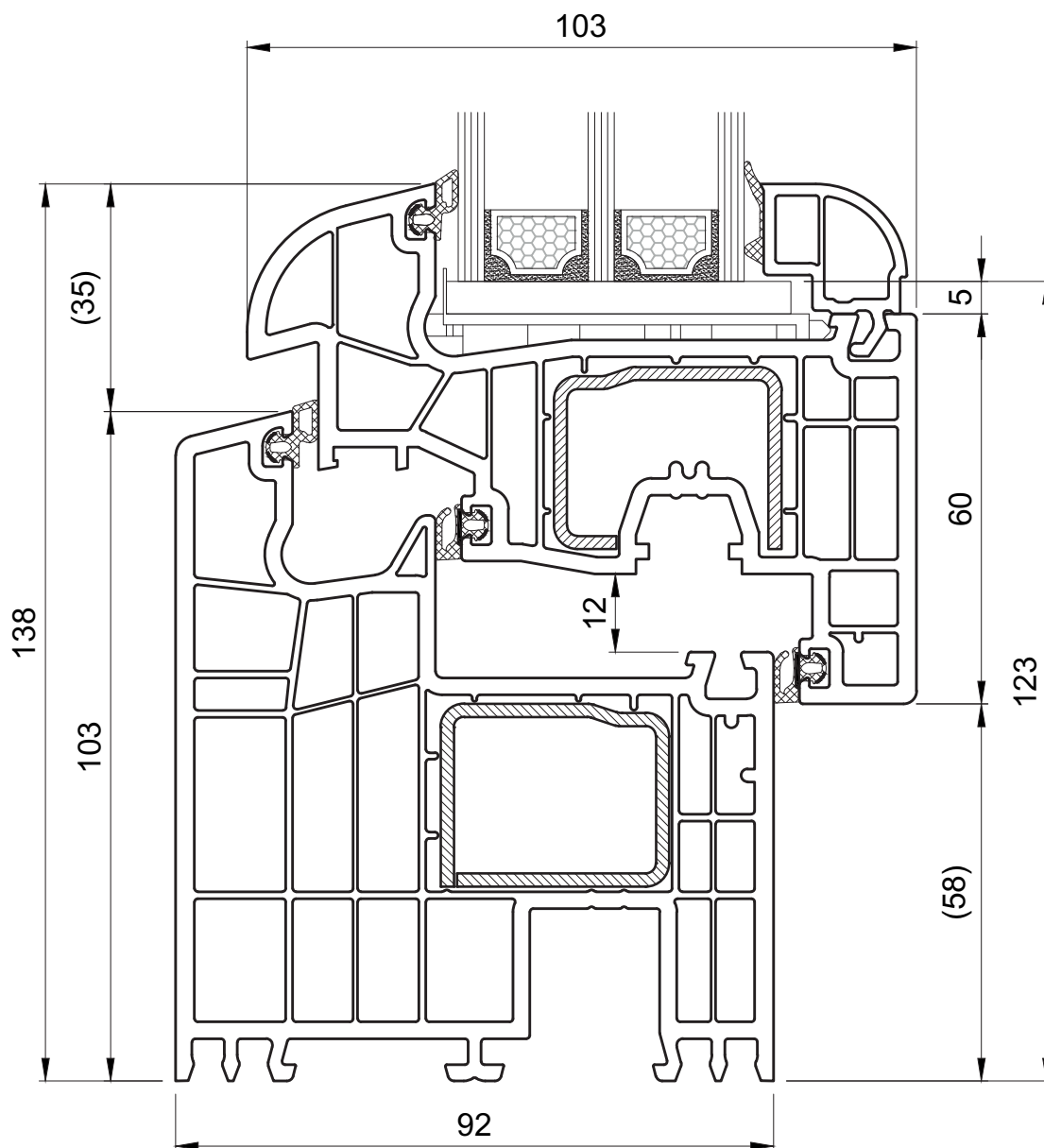
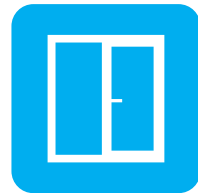





-  Skrzydło okienne Round-line z ramą 103 mm
-  Ouvrant Round-line avec dormant 103 mm
-  Flügel Round-line + kader 103 mm
-  Flügel Round-line mit Rahmen 103 mm
-  Ante Round-line con telaio 103 mm





# BluEvolution 92 **bE**

170 430 - 171 030

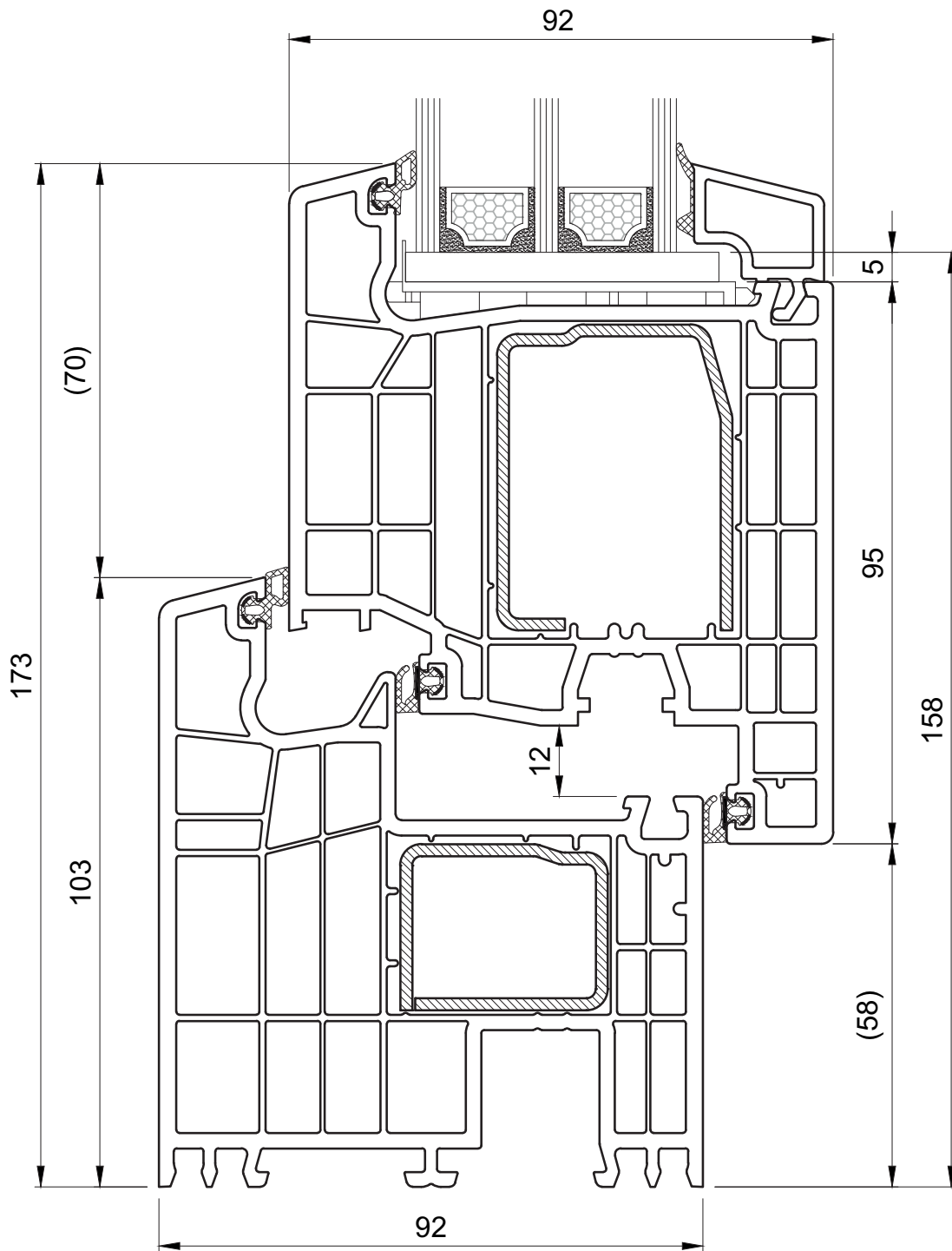

**SALAMANDER**  
WINDOW & DOOR SYSTEMS

Drzwi tarasowe, otwierane do wewnątrz



Porte de passage, ouverture vers l'intérieur



Terras profiel, naar binnen opendraaiend



Terassentür, nach Innen öffnend



Portaveranda, l'apertura verso interno



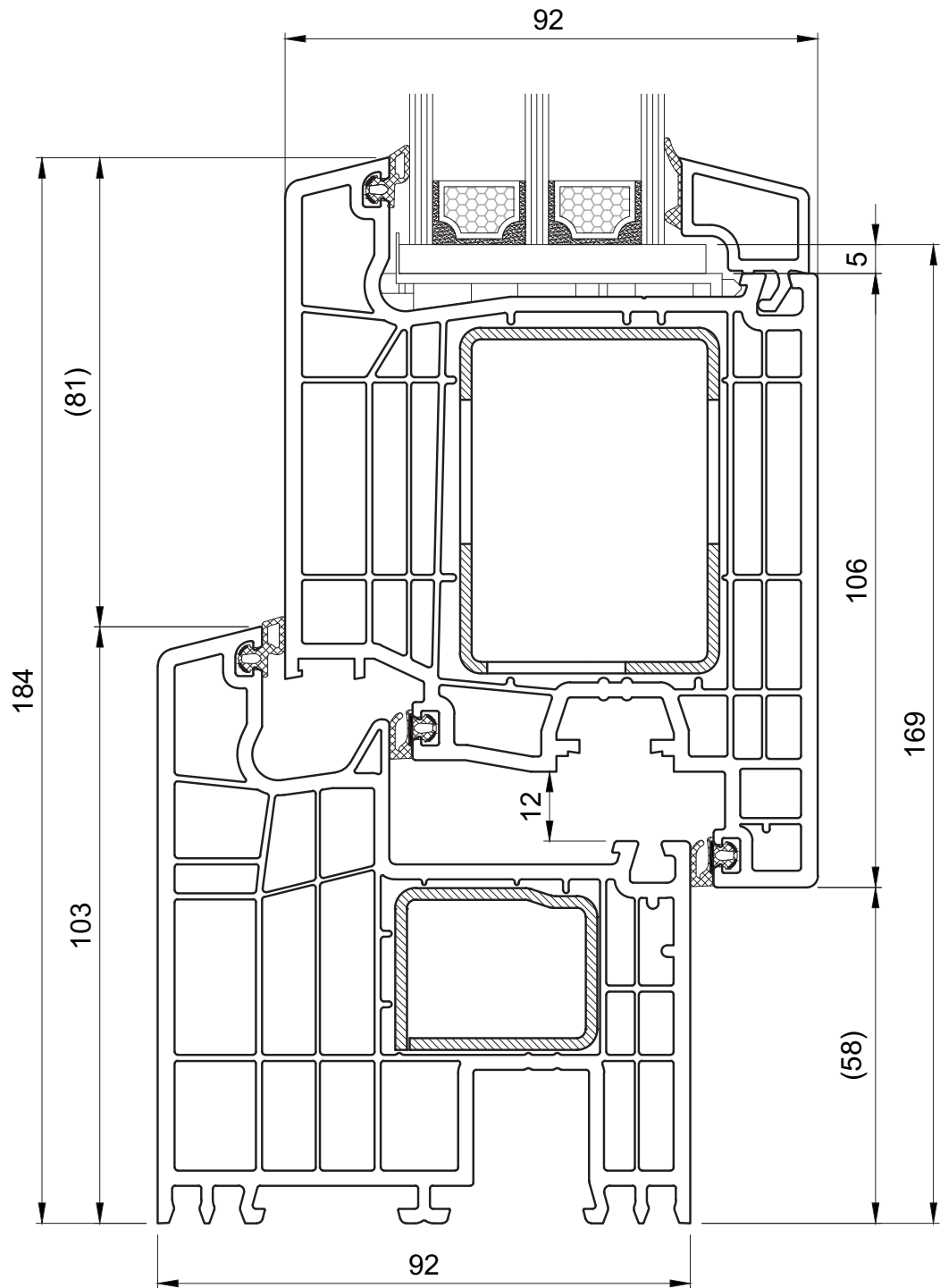

Drzwi wejściowe, otwierane do wewnątrz



Porte d'entrée, ouverture vers l'intérieur



Deur, naar binnen opendraaiend



Eingangstür, nach Innen öffnend



Porta d'ingresso, l'apertura verso interno

